



Guangzhou Guantu Electronic Technology Co., Ltd
广州冠图电子科技有限公司

HIGH VOLTAGE SMPS PRODUCT MANUAL
高压模块电源产品手册

COMPANY PROFILE 公司简介

Guangzhou Guantu Electronic Technology Co., Ltd. (named GTL-POWER) was founded in 2012, focusing on the developing, manufacturing, sales and service of **small and medium power HVDC (high voltage DC) power supply modules**, including general high input voltage power supply module, customized high input voltage or high output voltage power supply modules.

We have developed many series products of high input voltage power supplies for photovoltaic power generation (for current combination box, photovoltaic tracking bracket, and etc.) and energy storage system (ESS, including high-voltage home/household energy storage system, industrial and commercial energy storage system).

We are ready to provide power technical support, solution consultation and customized power supply services for any new or old customer.

广州冠图电子科技有限公司成立于 2012 年，是一家**专注于中小功率 HVDC 高压模块电源、定制电源及相关产品的研发、生产、销售和服务的技术型企业。**

主要产品有光伏高压输入模块电源、储能高压输入模块电源、高压输出模块电源、通用 AC/DC 模块电源、定制 AC/DC 模块电源、通用定压 DC/DC 模块电源、通用宽压 DC/DC 模块电源等多系列产品。所有产品都是自主研发，具备完全的知识产权。同时，公司以扎实的技术能力和丰富的行业经验，为客户提供电源产品及相关行业的项目咨询、系统设计和技术支持等服务。

PIN DEFINITION 引脚定义

+VI	Positive input for DC/DC converter	输入正极
-VI	Negative input for DC/DC converter	输入负极, 适用于 DC/DC 模块电源
+Vo	Positive output	输出正极
-Vo	Negative output	输出负极
Com	Common output for dual-output SMPS	输出公共地, 适用于输出为正负双路的模块电源
Ctrl	Control PIN for on/off function	开/关机控制引脚
Trim	Trimming PIN for output voltage	输出电压调节引脚
NC	No connection PIN	无功能引脚, 不能连接任何电路
No Pin	No PIN position	表示该位置没有引脚, 也写作 NP
L	Live wire for AC/DC converter	交流输入火线, 适用于 AC/DC 模块电源
N	Neutral wire for AC/DC converter	交流输入零线, 适用于 AC/DC 模块电源

目录

COMPANY PROFILE 公司简介	2
PIN DEFINITION 引脚定义	3
GH15 (25)-C2Sxx-01	4
GH15 (25)-V2Xxx	5
GH15-V2Xxx-S	7
GH25 (40)-V2Sxx-S-UL	8
GH25 (40)-V2Sxx-C-UL	9
GH40-CNxx	10
GH50-CNxx	11
GH50-V2Sxx-S-UL	12
GH50-V2Sxx-C-UL	13
GH60-CNxx	14
GH75-CNxx (-Lxx)	15
GH150-CNxx	16
GH150-CNxxU (-Lxx)	17
GH150-V2SxxU-SE (-Lxx)	18
GH150-V2SxxU-S (-DZ)	19
GH150-V3Sxx-S-CE	20
VA150-800B2SxxU (-Lxx)	21
GH200-VSxxU-S (-Lxx)	22
GH240-V2SxxU-LE (-Lxx)	23
GH260-V2SxxU-L (-Lxx)	24
GH350-V2SxxU-SE (-Lxx)	25
GH350-V4SxxU-S	26
VA350-V6Sxx	27
GSAxxxxxHS (D)-4 (8)	28
GHAxxxxxHS (D)-xx	30
GVAxxxxxAS-xx	32
PRODUCT MAP	34
CONTACT METHODS 联系方式	35

GH15(25)-C2Sxx-01

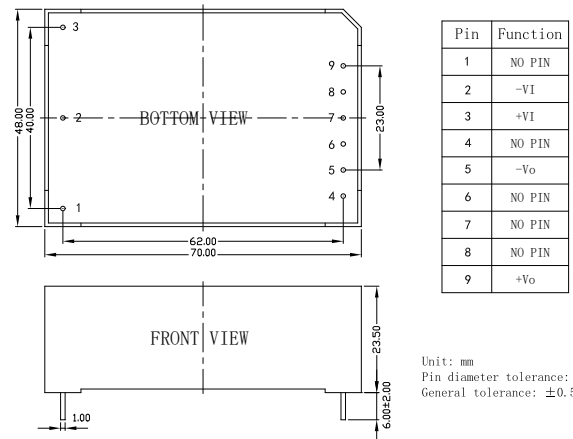

DC-DC Power Supply Module Ultra wide input, isolated single output

GH xx - C2 S xx - 01

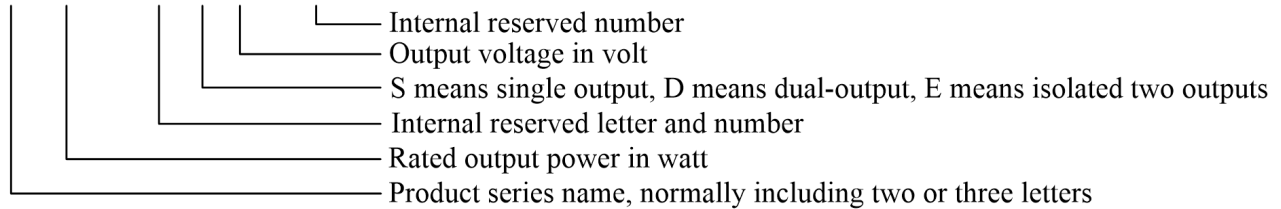

Product Characteristics

- Ultra wide input voltage range, 40-1000VDC
- Input reversed polarity protection
- Designed based on safety standards
- Output protection: OCP, SCP
- Input and output isolation, 4000VDC
- No minimum load requirement
- Applications: photovoltaic power station, energy storage system, other high voltage input industrial equipment

Model Selection Table

Model	Dimensions (L*W*H)	Rated power	Rated output voltage/current		Typical efficiency (Vin = 600VDC)
			Vo	Io	
GH15-C2S05-01	70.0*48.0*23.5mm (Plastic case)	15W	5V	3000mA	71%
GH15-C2S12-01			12V	1250mA	74%
GH15-C2S15-01			15V	1000mA	75%
GH15-C2S24-01			24V	625mA	79%
GH25-C2S05-01	72.0*50.0*23.5mm (Metal case)	25W	5V	5000mA	74%
GH25-C2S12-01			12V	2080mA	78%
GH25-C2S15-01			15V	1660mA	79%
GH25-C2S24-01			24V	1040mA	82%

GH15(25)-V2Xxx

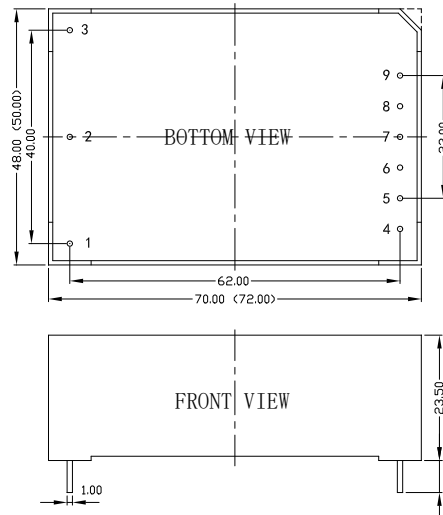

Pin	Function		
	V2S	V2D	V2E
1	NO PIN	NO PIN	NO PIN
2	-VI	-VI	-VI
3	+VI	+VI	+VI
4	NO PIN	NO PIN	NO PIN
5	-Vo	-Vo	-Vo1
6	NO PIN	NO PIN	+Vo1
7	NO PIN	COM	NO PIN
8	NO PIN	NO PIN	-Vo2
9	+Vo	+Vo	+Vo2

Unit: mm
 Pin diameter tolerance: ± 0.10
 General tolerance: ± 0.50

DC-DC Power Supply Module Ultra wide input, isolated single/dual output

GH xx - V2 X xx

- _____ Output voltage in volt
- _____ S means single output, D means dual-output, E means isolated two outputs
- _____ Internal reserved letter and number
- _____ Rated output power in watt
- _____ Product series name, normally including two or three letters

Product Characteristics

- Ultra wide input voltage range, 210-1200VDC
- High reliability, industrial grade
- Input and output isolation, 4000VDC
- Applications: photovoltaic power station, energy storage system, other high voltage input industrial equipment
- Input protection: UVP, reversed polarity protection
- Output protection: OCP, SCP
- No minimum load requirement

Model Selection Table

Model	Dimensions (L*W*H)	Rated power	Rated output voltage/current		Typical efficiency ($V_{in} = 600VDC$)
			Vo1/Io1	Vo2/Io2	
GH15-V2S05	70.0*48.0*23.5mm (Plastic case)	15W	5V/3000mA	-	73%
GH15-V2S12			12V/1250mA	-	80%
GH15-V2S15			15V/1000mA	-	81%
GH15-V2S24			24V/625mA	-	82%
GH15-V2D05			+5V/1500mA	-5V/1500mA	72%
GH15-V2D12			+12V/625mA	-12V/625mA	78%

GH15-V2D15			+15V/500mA	-15V/500mA	80%
GH15-V2D24			+24V/312mA	-24V/312mA	81%
GH15-V2E0505			5V/2000mA	5V/1000mA	73%
GH15-V2E0512			5V/2000mA	12V/420mA	76%
GH15-V2E0524			5V/2000mA	24V/210mA	78%
GH25-V2S05	72.0*50.0*23.5mm (Metal case)	25W	5V/5000mA	-	74%
GH25-V2S12			12V/2080mA	-	80%
GH25-V2S15			15V/1660mA	-	81%
GH25-V2S24			24V/1040mA	-	83%
GH25-V2D05			+5V/2500mA	-5V/2500mA	72%
GH25-V2D12			+12V/1040mA	-12V/1040mA	81%
GH25-V2D15			+15V/830mA	-15V/830mA	82%
GH25-V2D24			+24V/520mA	-24V/520mA	83%
GH25-V2E0505			5V/3000mA	5V/2000mA	72%
GH25-V2E0512			5V/3000mA	12V/830mA	74%
GH25-V2E0524			5V/3000mA	24V/420mA	75%

GH15-V2Xxx-S

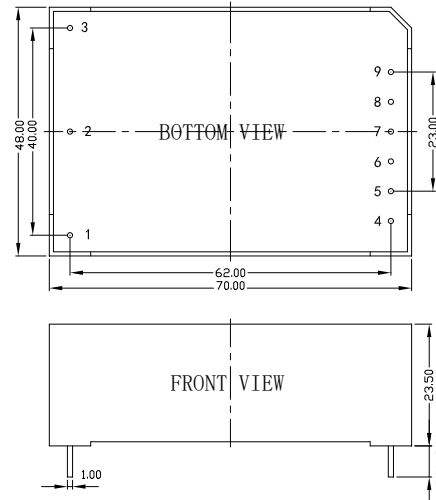

Pin	Function		
	V2S	V2D	V2E
1	NO PIN	NO PIN	NO PIN
2	-VI	-VI	-VI
3	+VI	+VI	+VI
4	NO PIN	NO PIN	NO PIN
5	-Vo	-Vo	-Vo1
6	NO PIN	NO PIN	+Vo1
7	NO PIN	COM	NO PIN
8	NO PIN	NO PIN	-Vo2
9	+Vo	+Vo	+Vo2

Unit: mm
 Pin diameter tolerance: ± 0.10
 General tolerance: ± 0.50

DC-DC Power Supply Module Ultra wide input, isolated single/dual output

Product Characteristics

- Ultra wide input voltage range, 300-1500VDC
- High reliability, industrial grade
- Input and output isolation, 4000VDC
- Applications: photovoltaic power station, energy storage system, other high voltage input industrial equipment
- Input protection: UVP, reversed polarity protection
- Output protection: OCP, SCP
- No minimum load requirement

Model Selection Table

Model	Dimensions (L*W*H)	Rated power	Rated output voltage/current		Typical efficiency ($V_{in} = 600VDC$)
			Vo1/Io1	Vo2/Io2	
GH15-V2S05-S	70.0*48.0*23.5mm	15W	5V/3000mA	-	65%
GH15-V2S12-S			12V/1250mA	-	71%
GH15-V2S15-S			15V/1000mA	-	72%
GH15-V2S24-S			24V/625mA	-	78%
GH15-V2S32-S			32V/470mA	-	73%
GH15-V2D12-S		15W	+12V/625mA	-12V/625mA	78%
GH15-V2D15-S			+15V/500mA	-15V/500mA	80%
GH15-V2E0512-S		15W	5V/2000mA	12V/420mA	76%
GH15-V2E0515-S			5V/2000mA	15V/330mA	77%
GH15-V2E0524-S			5V/2000mA	24V/210mA	78%

GH25(40)-V2Sxx-S-UL

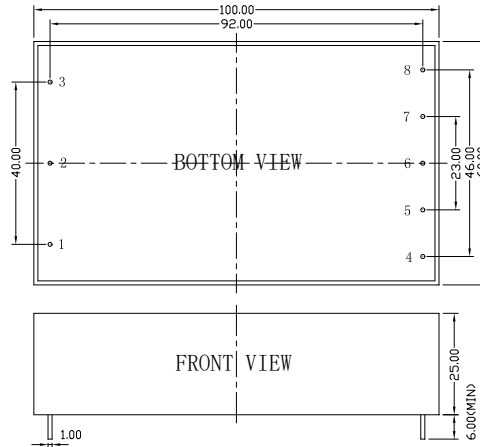

Pin PCB PAD recommendation

- Top/bottom paste/solder, D = 4mm
- Through hole, D = 1.3mm
- Four Vias, D = 0.4mm

Pin	Function
1	NO PIN
2	-VI
3	+VI
4	NO PIN
5	-Vo
6	NO PIN
7	+Vo
8	NO PIN

Unit: mm
 Pin diameter tolerance: ± 0.10
 General tolerance: ± 0.50

DC-DC Power Supply Module Ultra wide input, isolated single output

Product Characteristics

- Ultra wide input voltage range, 300-1500VDC
- Designed based on EN62109 and UL1741
- Input and output isolation, 4000VAC
- Applications: photovoltaic power station, energy storage system, other high voltage input industrial equipment
- Input protection: UVP, reversed polarity protection
- Output protection: OCP, SCP
- No minimum load requirement

Model Selection Table

Model	Dimensions (L*W*H)	Rated power	Rated output voltage/current		Typical efficiency (Vin=1000VDC)
			Vo	Io	
GH25-V2S05-S-UL	100*60*25mm	20W	5V	4000mA	70%
GH25-V2S12-S-UL			12V	2080mA	72%
GH25-V2S24-S-UL			24V	1040mA	74%
GH25-V2S28-S-UL			28V	890mA	75%
GH25-V2S32-S-UL			32V	780mA	77%
GH40-V2S05-S-UL	100*60*25mm	30W	5V	6000mA	75%
GH40-V2S12-S-UL			12V	3330mA	78%
GH40-V2S24-S-UL			24V	1660mA	80%
GH40-V2S28-S-UL			28V	1430mA	81%
GH40-V2S32-S-UL			32V	1250mA	82%

GH25(40)-V2Sxx-C-UL

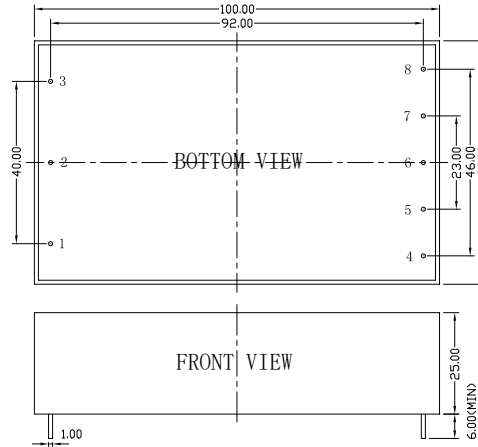

Pin PCB PAD recommendation

- Top/bottom paste/solder, D = 4mm
- Through hole, D = 1.3mm
- Four Vias, D = 0.4mm

Pin	Function
1	NO PIN
2	-VI
3	+VI
4	NO PIN
5	-Vo
6	NO PIN
7	+Vo
8	NO PIN

Unit: mm
Pin diameter tolerance: ± 0.10
General tolerance: ± 0.50

DC-DC Power Supply Module Ultra wide input, isolated single output

Product Characteristics

- Ultra wide input voltage range, 300-1500VDC
- Designed based on EN62109 and UL1741
- Input and output isolation, 4000VAC
- Applications: photovoltaic power station, energy storage system, other high voltage input industrial equipment
- Input protection: UVP, reversed polarity protection
- Output protection: OCP, SCP
- **CCCV output (constant current and constant voltage)**

Model Selection Table

Model	Dimensions (L*W*H)	Rated power	Rated output voltage/current		Typical efficiency ($V_{in}=1000VDC$)		
			V_o / I_o				
GH25-V2S24-C-UL	100*60*25mm	25W	CC mode	18-24V/1040mA	80%		
GH25-V2S26-C-UL			CV mode	24V/850mA			
GH25-V2S32-C-UL			CC mode	18-26V/970mA	81%		
			CV mode	26V/800mA			
GH40-V2S24-C-UL			100*60*25mm	40W	CC mode	24-32V/780mA	82%
					CV mode	32V/670mA	
GH40-V2S28-C-UL	CC mode	16-24V/1660mA			78%		
	CV mode	24V/1200mA					
GH40-V2S32-C-UL	CC mode	16-28V/1430mA			80%		
	CV mode	28V/1000mA					
GH40-V2S32-C-UL	CC mode	16-32V/1250mA	82%				
	CV mode	32V/900mA					

GH40-CNxx

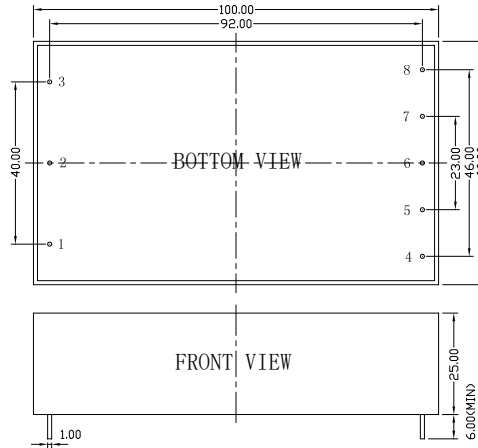

Pin PCB PAD recommendation
 Top/bottom paste/solder, D = 4mm
 Through hole, D = 1.3mm
 Four Vias, D = 0.4mm

Pin	Function
1	NO PIN
2	-VI
3	+VI
4	NO PIN
5	-Vo
6	NO PIN
7	+Vo
8	NO PIN

Unit: mm
 Pin diameter tolerance: ± 0.10
 General tolerance: ± 0.50

DC-DC Power Supply Module Ultra wide input, isolated single output

GH xx - CN xx

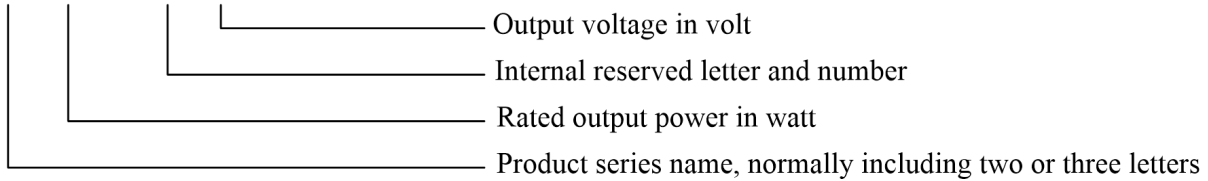

Product Characteristics

- Ultra wide input voltage range, 80-800VDC
- Designed based on EN62477-1
- Input and output isolation, 4000VDC
- Applications: energy storage system, photovoltaic power station, other high voltage input industrial equipment
- Input reversed polarity protection
- Output protection, OCP and SCP
- No minimum load requirement

Model Selection Table

Model	Dimensions (L*W*H)	Rated power	Rated output voltage/current		Typical efficiency (Vin=400VDC)
			Vo	Io	
GH40-CN12	100*60*25mm	40W	12V	3330mA	73%
GH40-CN15			15V	2660mA	75%
GH40-CN24			24V	1660mA	76%
GH40-CN28			28V	1420mA	78%
GH40-CN32			32V	1250mA	80%

GH50-CNxx

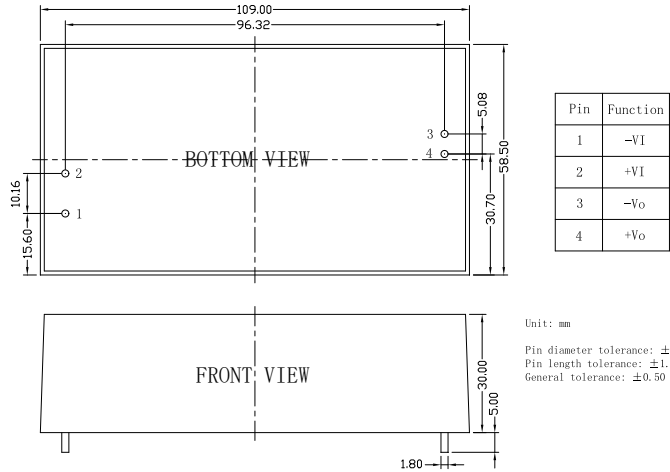

DC-DC Power Supply Module Ultra wide input, isolated single output

GH xx - CN xx

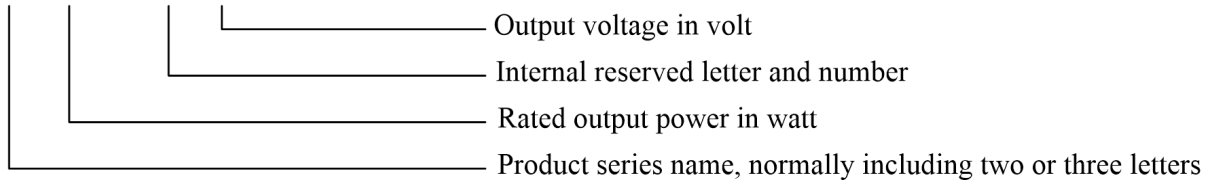

Product Characteristics

- Ultra wide input voltage range, 80-750VDC
- Designed based on safety standards
- Input and output isolation, 4000VAC
- Applications: energy storage system, photovoltaic power station, other high voltage input industrial equipment
- Input reversed polarity protection
- Output protection, OCP and SCP
- No minimum load requirement

Model Selection Table

Model	Dimensions (L*W*H)	Rated power	Rated output voltage/current		Typical efficiency ($V_{in}=350VDC$)
			V_o	I_o	
GH50-CN12	109*58.5*30mm	50W	12V	4160mA	81%
GH50-CN15			15V	3330mA	83%
GH50-CN24			24V	2080mA	85%
GH50-CN28			28V	1780mA	85%
GH50-CN32			32V	1560mA	85%

GH50-V2Sxx-S-UL

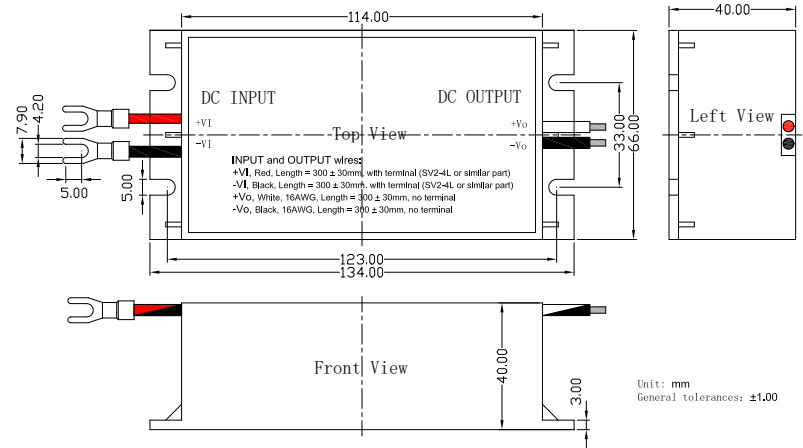
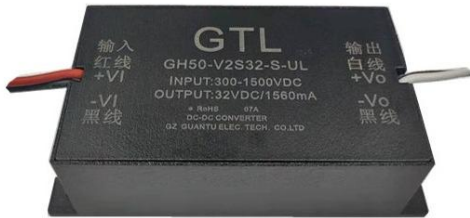

DC-DC Power Supply Module Ultra wide input, isolated single output

GH xx - V2 S xx - S - UL

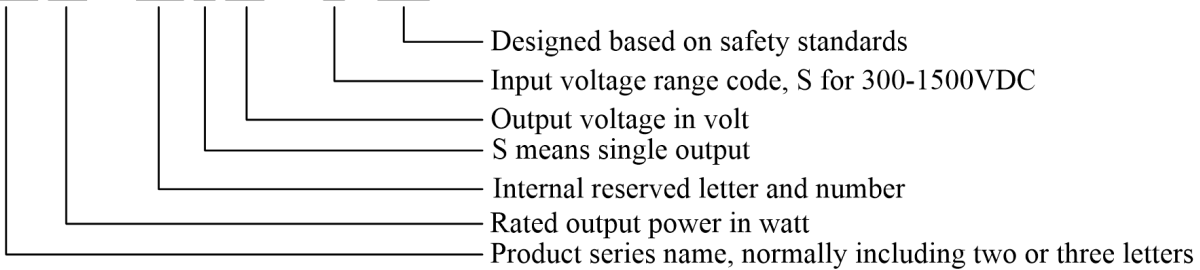

Product Characteristics

- Ultra wide input voltage range, 300-1500VDC
- Designed based on safety standards
- Input and output isolation, 4000VDC
- Applications: photovoltaic power station, energy storage system, other high voltage input industrial equipment
- Input protection: UVP, reversed polarity protection
- Output protection: OCP, SCP
- No minimum load requirement

Model Selection Table

Model	Dimensions (L*W*H)	Rated power	Rated output voltage/current		Typical efficiency (Vin=1000VDC)
			Vo	Io	
GH50-V2S12-S-UL	134*66*40mm	50W	12V	4170mA	80%
GH50-V2S15-S-UL			15V	3330mA	81%
GH50-V2S24-S-UL			24V	2080mA	81%
GH50-V2S28-S-UL			28V	1780mA	82%
GH50-V2S32-S-UL			32V	1560mA	82%

GH50-V2Sxx-C-UL

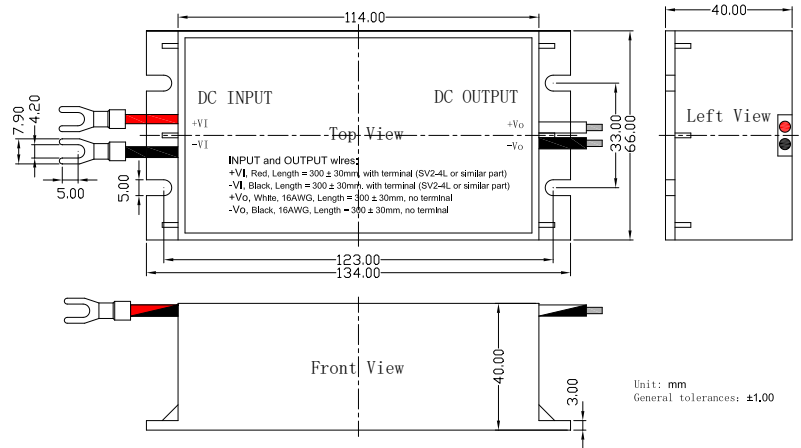
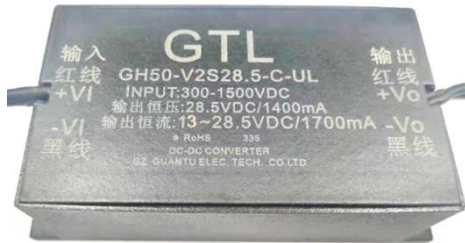

DC-DC Power Supply Module Ultra wide input, isolated single output

GH xx - V2 S xx - C - UL

- Designed based on safety standards
- **Constant current mode (CC) and constant voltage mode (CV)**
- Output voltage in volt, in constant voltage working status
- S means single output
- Internal reserved letter and number
- Rated output power in watt
- Product series name, normally including two or three letters

Product Characteristics

- Ultra wide input voltage range, 300-1500VDC
- Designed based on safety standards
- Input and output isolation, 4000VDC
- Applications: photovoltaic power station, energy storage system, other high voltage input industrial equipment
- Input protection: UVP, reversed polarity protection
- Output protection: OCP, SCP
- No minimum load requirement

Model Selection Table

Model	Dimensions (L*W*H)	Rated power	Rated output voltage/current		Typical efficiency (Vin=1000VDC)
			Mode	Vo / Io	
GH50-V2S24-C-UL	134*66*40mm	50W	CC mode	13-24V/2080mA	80%
			CV mode	24V/1800mA	
GH50-V2S28.5-C-UL			CC mode	13-28.5V/1700mA	81%
			CV mode	28.5V/1400mA	
GH50-V2S32-C-UL			CC mode	18-32V/1560mA	82%
			CV mode	32V/1300mA	

GH60-CNxx

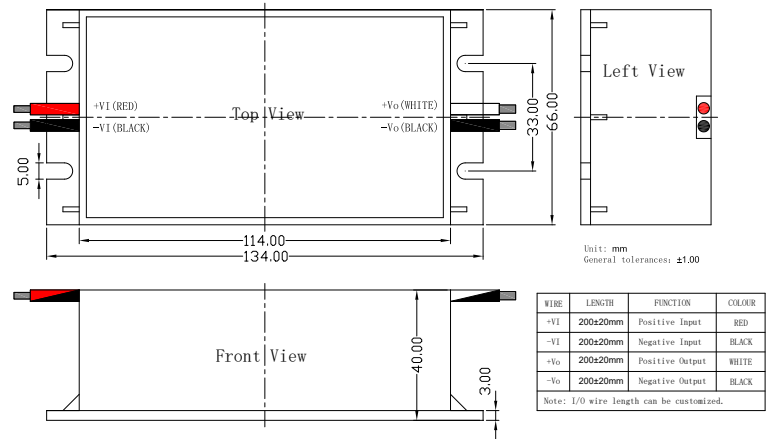

DC-DC Power Supply Module Ultra wide input, isolated single output

GH xx - CN xx

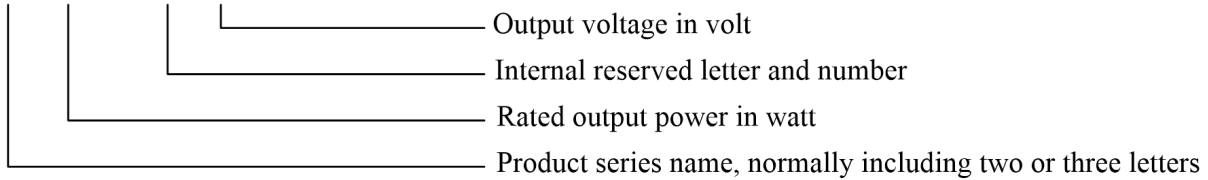

Product Characteristics

- Ultra wide input voltage range, 80-800VDC
- Standard, CE (EN62477-1)
- Input and output isolation, 4000VDC
- Applications: energy storage system, photovoltaic power station, other high voltage input industrial equipment
- Input reversed polarity protection
- Output protection, OCP and SCP
- No minimum load requirement

Model Selection Table

Model	Dimensions (L*W*H)	Rated power	Rated output voltage/current		Typical efficiency (Vin=400VDC)
			Vo	Io	
GH60-CN12	134*66*40mm	50W	12V	4160mA	80%
GH60-CN15			15V	4000mA	81%
GH60-CN24		60W	24V	2500mA	81%
GH60-CN28			28V	2140mA	82%
GH60-CN32			32V	1870mA	82%

GH75-CNxx(-Lxx)

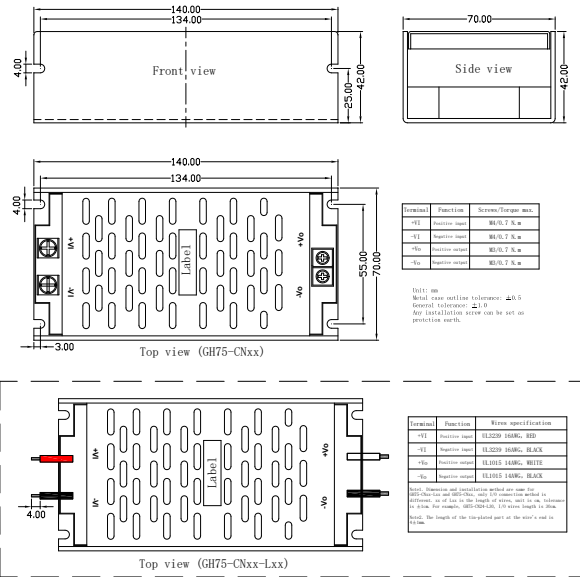

DC-DC Power Supply Module Ultra wide input, isolated single output

GH xx - CN xx - Lxx

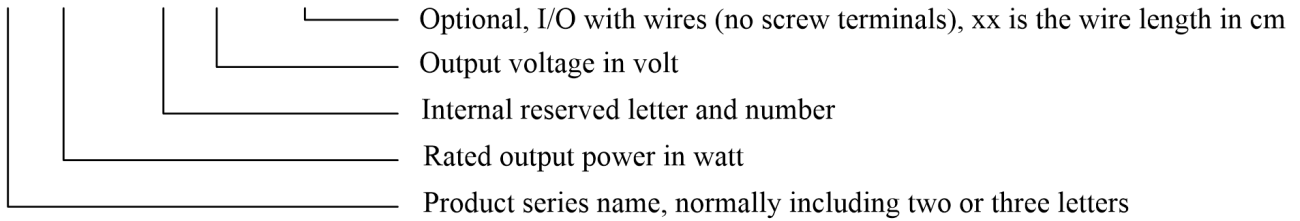

Product Characteristics

- Ultra wide input voltage range, 80-1000VDC
- Standard, CE (EN62477-1)
- Input and output isolation, 4000VAC
- Applications: energy storage system, photovoltaic power station, other high voltage input industrial equipment
- Input reversed polarity protection, UVP
- Output protection, OCP and SCP
- No minimum load requirement

Model Selection Table

Model	Dimensions (L*W*H)	Output power		Output voltage/current		Typical efficiency (Vin=500VDC)
		NORMAL	PULSE	Vo	Io	
GH75-CN12	140*70*42mm	75W	120W (3seconds max.)	12V	6250mA	80%
GH75-CN15				15V	5000mA	82%
GH75-CN24				24V	3120mA	83%
GH75-CN28				28V	2670mA	85%
GH75-CN32				32V	2340mA	86%
GH75-CN48				48V	1560mA	86%

GH150-CNxx

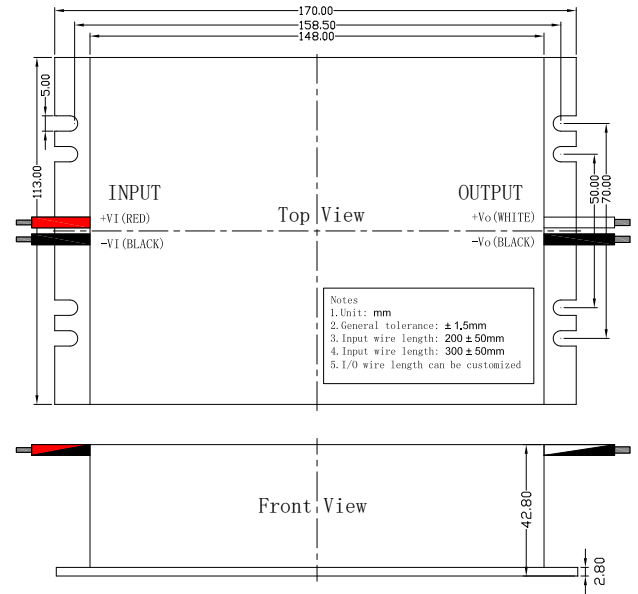

DC-DC Power Supply Module Ultra wide input, isolated single output

Product Characteristics

- Ultra wide input voltage range, 100-1000VDC
- Standard, CE (EN62477-1)
- Input and output isolation, 4000VDC
- Applications: energy storage system, photovoltaic power station, other high voltage input industrial equipment
- Input reversed polarity protection
- Output protection, OCP and SCP
- No minimum load requirement

Model Selection Table

Model	Dimensions (L*W*H)	Rated power	Rated output voltage/current		Typical efficiency (Vin=500VDC)
			Vo	Io	
GH150-CN12	170.0*113*42.8mm	100W	12V	8330mA	81%
GH150-CN15			15V	6670mA	82%
GH150-CN24		150W	24V	6250mA	83%
GH150-CN27			27V	5550mA	85%
GH150-CN28			28V	5350mA	85%
GH150-CN32			32V	4680mA	86%
GH150-CN48			48V	3120mA	88%

GH150-CNxxU(-Lxx)

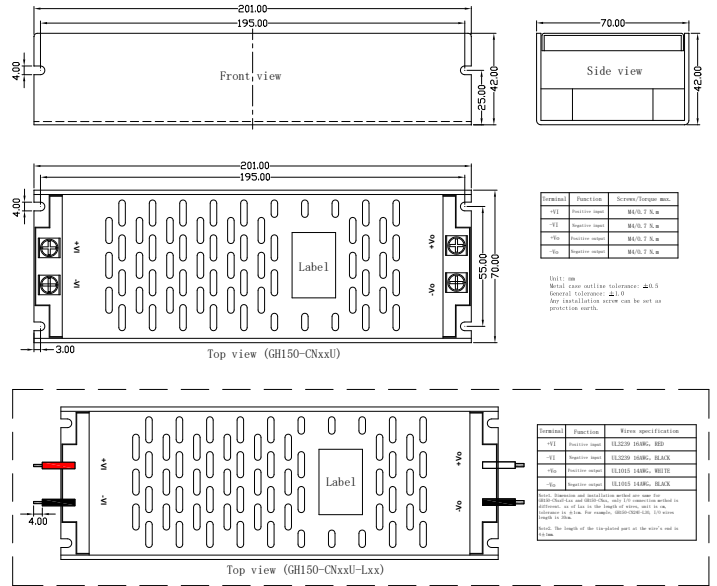

DC-DC Power Supply Module Ultra wide input, isolated single output

Product Characteristics

- Ultra wide input voltage range, 100-1000VDC
- Standard, CE (EN62477-1)
- Input and output isolation, 4000VAC
- Applications: energy storage system, photovoltaic power station, other high voltage input industrial equipment
- Input reversed polarity protection, input UVP
- Output protection, OCP and SCP
- No minimum load requirement

Model Selection Table

Model	Dimensions (L*W*H)	Rated power	Rated output voltage/current		Typical efficiency (Vin=500VDC)
			Vo	Io	
GH150-CN12U	201*70*42mm	100W	12V	8330mA	80%
GH150-CN15U			15V	6670mA	82%
GH150-CN24U		150W	24V	6250mA	83%
GH150-CN28U			28V	5350mA	85%
GH150-CN32U			32V	4680mA	86%
GH150-CN48U			48V	3120mA	86%

Note: Adding suffix of “-Lxx” means the module has input and output wires, and “xx” is the length with unit of cm, please reference to the related description in the dimension drawing.

GH150-V2SxxU-SE(-Lxx)

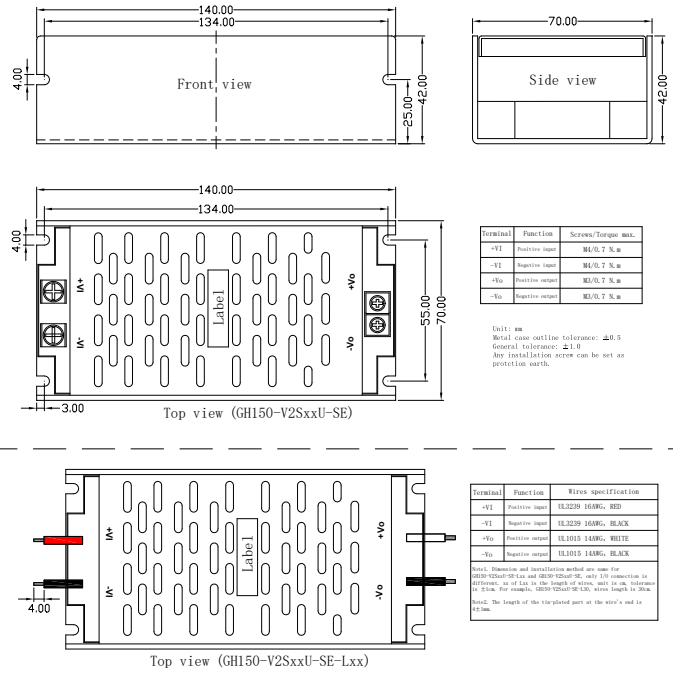

DC-DC Power Supply Module Ultra wide input, isolated single output

Product Characteristics

- Ultra wide input voltage range, 250-1500VDC
- Designed reference to EN62109 and UL1741
- Input and output isolation, 4000VAC
- Applications: photovoltaic power station, energy storage system, other high voltage input industrial equipment
- Input reversed polarity protection, UVP
- Output protection, OCP and SCP
- No minimum load requirement

Model Selection Table

Model	Dimensions (L*W*H)	Rated power	Rated output voltage/current		Typical efficiency (Vin=1000VDC)
			Vo	Io	
GH150-V2S12U-SE	140*70*42mm	100W	12V	8330mA	80%
GH150-V2S15U-SE			15V	6770mA	82%
GH150-V2S24U-SE		150W	24V	6250mA	83%
GH150-V2S28U-SE			28V	5350mA	85%
GH150-V2S32U-SE			32V	4680mA	86%
GH150-V2S48U-SE			48V	3120mA	86%

Note: Adding suffix of “-Lxx” means the module has input and output wires, and “xx” is the length with unit of cm, please reference to the related description in the dimension drawing.

GH150-V2SxxU-S(-DZ)

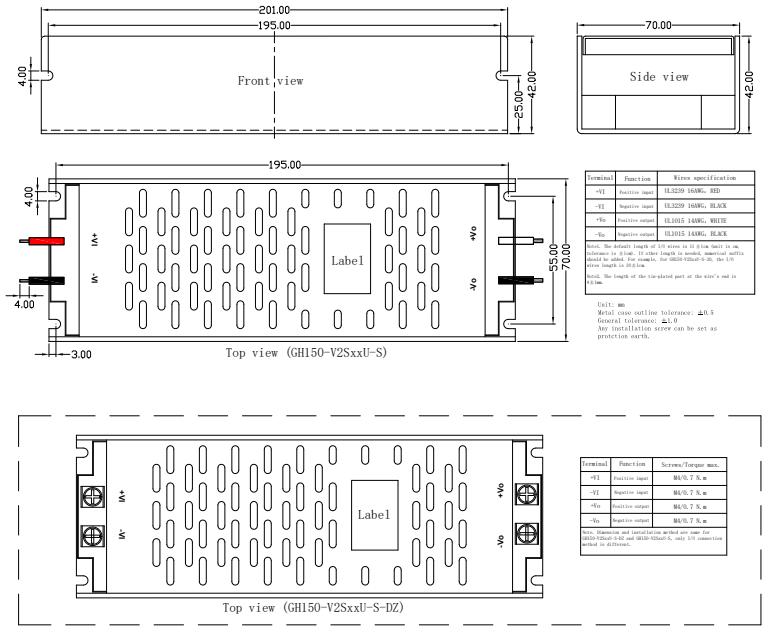

DC-DC Power Supply Module Ultra wide input, isolated single output

Product Characteristics

- Ultra wide input voltage range, 250-1500VDC
- Designed reference to EN62109 and UL1741
- Input and output isolation, 4000VAC
- Applications: photovoltaic power station, energy storage system, other high voltage input industrial equipment
- Input reversed polarity protection, UVP
- Output protection, OCP and SCP
- No minimum load requirement

Model Selection Table

Model	Dimensions (L*W*H)	Rated power	Rated output voltage/current		Typical efficiency (Vin=1000VDC)
			Vo	Io	
GH150-V2S12U-S	201*70*42mm	100W	12V	8330mA	80%
GH150-V2S15U-S			15V	6670mA	82%
GH150-V2S24U-S		150W	24V	6250mA	83%
GH150-V2S28U-S			28V	5350mA	85%
GH150-V2S32U-S			32V	4680mA	86%
GH150-V2S48U-S			48V	3120mA	86%

Note: Adding digital suffix “-xx” means the module has input and output wires with the length of xx cm (default length is 11cm). Suffix of “-DZ” means terminal connection method (no I/O wires). Please reference to the dimension drawing description for more detail.

GH150-V3Sxx-S-CE

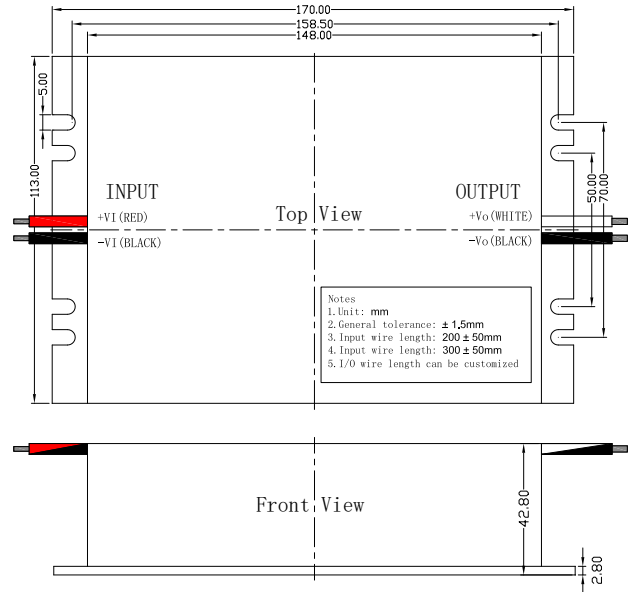

DC-DC Power Supply Module Ultra wide input, isolated single output

Product Characteristics

- Ultra wide input voltage range, 300-1500VDC
- Standard, CE (EN62109-1)
- Input and output isolation, 4000VDC
- Applications: photovoltaic power station, energy storage system, other high voltage input industrial equipment
- Input reversed polarity protection, UVP
- Output protection, OCP and SCP
- No minimum load requirement

Model Selection Table

Model	Dimensions (L*W*H)	Rated power	Rated output voltage/current		Typical efficiency (Vin=1000VDC)
			Vo	Io	
GH150-V3S12-S-CE	170.0*113*42.8mm	80W *120W pulse	12V	6670mA / *10000mA	80%
GH150-V3S15-S-CE			15V	5330mA / *8000mA	82%
GH150-V3S24-S-CE		100W *150W pulse	24V	4160mA / *6250mA	83%
GH150-V3S28-S-CE			28V	3570mA / *5350mA	85%
GH150-V3S32-S-CE			32V	3125mA / *4680mA	86%
GH150-V3S48-S-CE			48V	2080mA / *3120mA	88%

*Comment: for most applications, such as solar tracker, energy storage system, where pulse power is needed while average power is not high, GH150-V3S24-S-CE is suitable, please reference to the derating curves.

VA150-800B2SxxU(-Lxx)

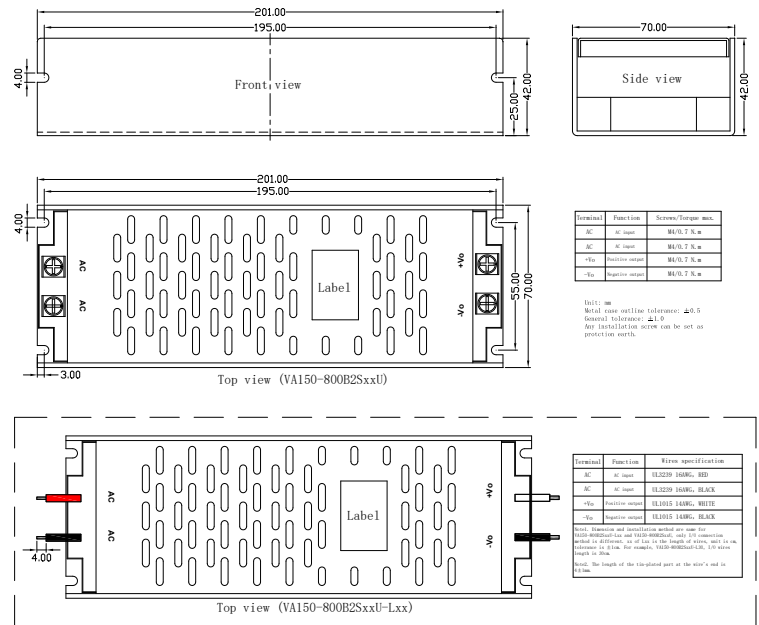

DC-DC Power Supply Module Ultra wide input, isolated single output

Product Characteristics

- Input voltage range, 300-1000VAC or 300-1500VDC
- Input under voltage protection (UVP)
- High reliability, industrial grade
- Output protection, OCP and SCP
- Input and output isolation, 4000VAC
- No minimum load requirement
- Applications: photovoltaic power station, energy storage system, other high voltage input industrial equipment

Model Selection Table

Model (A-TYPE)	Dimensions (L*W*H)	Rated power	Rated output voltage/current		Typical efficiency (Vin=800VAC)
			Vo	Io	
VA150-800B2S12U	201*70*42mm	100W	12V	8330mA	82%
VA150-800B2S15U			15V	6770mA	82%
VA150-800B2S24U		150W	24V	6250mA	83%
VA150-800B2S28U			28V	5350mA	85%
VA150-800B2S32U			32V	4680mA	86%
VA150-800B2S48U			48V	3120mA	86%

Note: Adding suffix of “-Lxx” means the module has input and output wires, and “xx” is the length with unit of cm, please reference to the related description in the dimension drawing.

GH200-VSxxU-S(-Lxx)

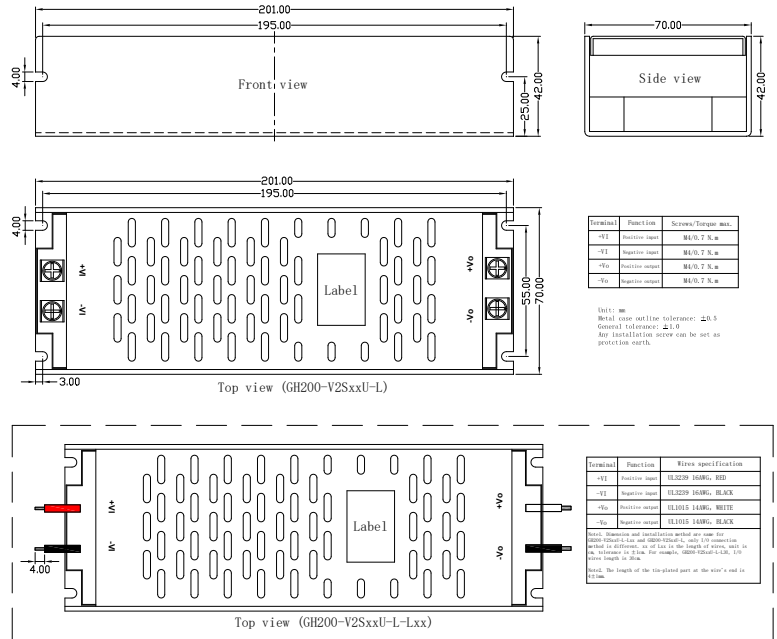

DC-DC Power Supply Module Ultra wide input, isolated single output

Product Characteristics

- Ultra wide input voltage range, 250-1500VDC
- Designed reference to EN62109 and UL1741
- Input and output isolation, 4000VAC
- Applications: photovoltaic power station, energy storage system, other high voltage input industrial equipment
- Input reversed polarity protection, UVP
- Output protection, OCP and SCP
- No minimum load requirement

Model Selection Table

Model	Dimensions (L*W*H)	Rated power	Rated output voltage/current		Typical efficiency (Vin=1000VDC)
			Vo	Io	
GH200-V2S12U-S	201*70*42mm	120W	12V	10000mA	80%
GH200-V2S15U-S			15V	8000mA	82%
GH200-V2S24U-S		200W	24V	8330mA	83%
GH200-V2S28U-S			28V	7140mA	85%
GH200-V2S32U-S			32V	6250mA	86%
GH200-V2S48U-S			48V	4160mA	86%

Note: Adding suffix of “-Lxx” means the module has input and output wires, “xx” is the length with unit of cm (default length is 11cm), please reference to the related description in the dimension drawing.

GH240-V2SxxU-LE(-Lxx)

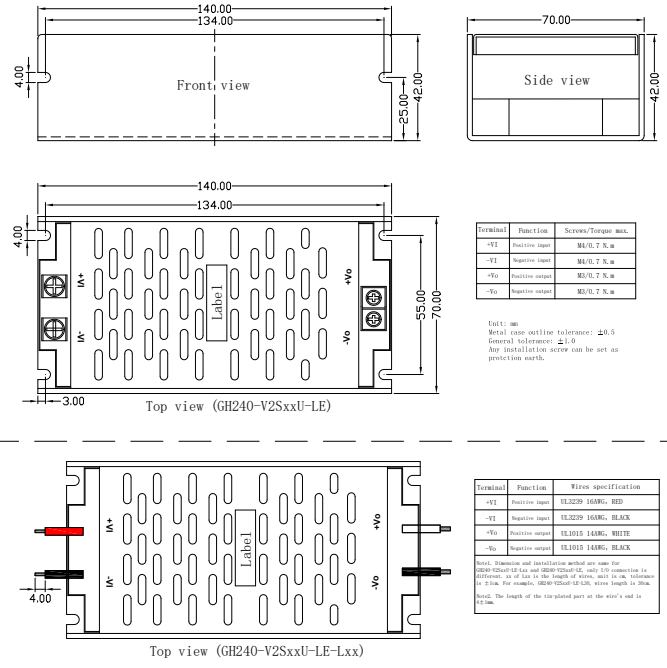
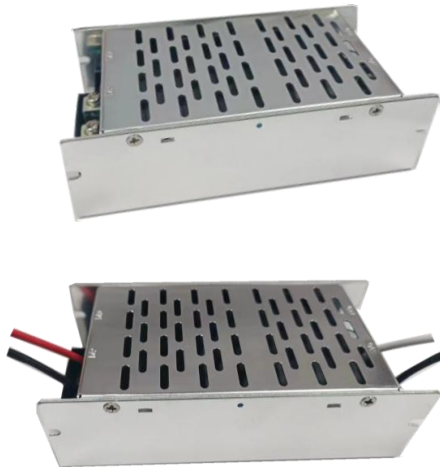

DC-DC Power Supply Module Ultra wide input, isolated single output

Product Characteristics

- Ultra wide input voltage range, 250-1000VDC
- Designed reference to EN62109 and UL1741
- Input and output isolation, 4000VAC
- Applications: photovoltaic power station, energy storage system, other high voltage input industrial equipment
- Input reversed polarity protection, UVP
- Output protection, OCP and SCP
- No minimum load requirement

Model Selection Table

Model	Dimensions (L*W*H)	Output power		Output voltage/current		Typical efficiency (Vin=600VDC)
		RATED	PULSE	RATED	PULSE	
GH240-V2S12U-LE	140*70*42mm	100W	160W (10min)	12V/8.33A	12V/13.3A	82%
GH240-V2S15U-LE				15V/6.67A	15V/10.6A	83%
GH240-V2S24U-LE		150W	240W (10min)	24V/6.25A	24V/10.0A	87%
GH240-V2S28U-LE				28V/5.35A	28V/8.57A	87%
GH240-V2S32U-LE				32V/4.68A	32V/7.50A	88%
GH240-V2S48U-LE				48V/3.12A	48V/5.00A	90%

Note: Adding suffix of “-Lxx” means the module has input and output wires, and “xx” is the length with unit of cm, please reference to the related description in the dimension drawing.

GH260-V2SxxU-L(-Lxx)

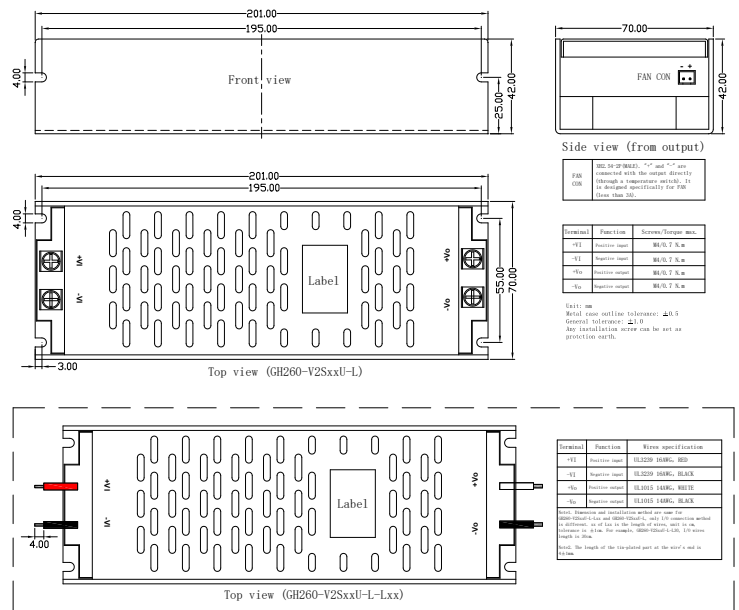

DC-DC Power Supply Module Ultra wide input, isolated single output

Product Characteristics

- Ultra wide input voltage range, 250-1000VDC
- Designed reference to EN62109 and UL1741
- Input and output isolation, 4000VAC
- Applications: photovoltaic power station, energy storage system, other high voltage input industrial equipment
- Input reversed polarity protection, UVP
- Output protection, OCP and SCP
- No minimum load requirement

Model Selection Table

Model	Dimensions (L*W*H)	Output power	Output voltage/current		Typical efficiency ($V_{in}=600VDC$)
			V_o	I_o	
GH260-V2S12U-L	201*70*42mm	150W	12V	12500mA	82%
GH260-V2S15U-L			15V	10000mA	83%
GH260-V2S24U-L		260W	24V	10830mA	87%
GH260-V2S28U-L			28V	9280mA	87%
GH260-V2S32U-L			32V	8120mA	88%
GH260-V2S48U-L			48V	5410mA	90%

Note1: Adding suffix of “-Lxx” means the module has input and output wires, “xx” is the length with unit of cm, please reference to the related description in the dimension drawing.

Note2: For 24V or higher output voltage module, forced air cooling (through fan) should be configured if continuous output power reaches 240W.

GH350-V2SxxU-SE(-Lxx)

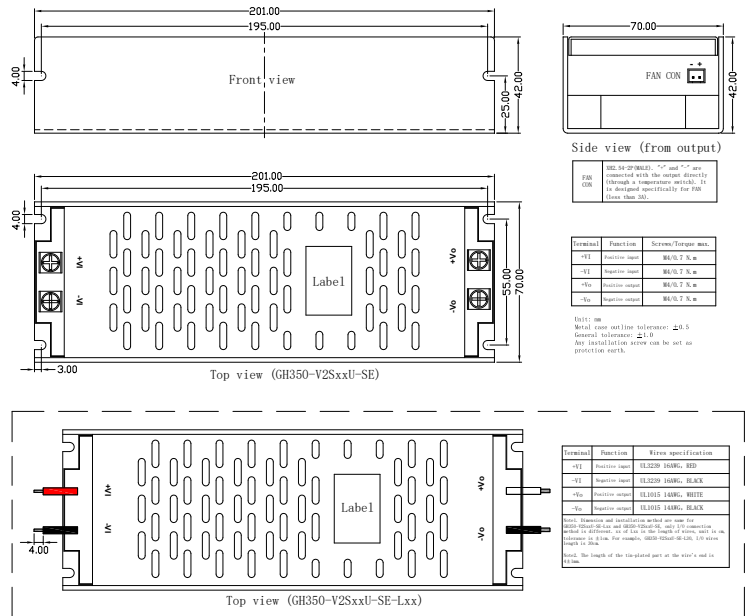

DC-DC Power Supply Module Ultra wide input, isolated single output

Product Characteristics

- Ultra wide input voltage range, 250-1500VDC
- Designed reference to EN62109 and UL1741
- Input and output isolation, 4000VAC
- Applications: photovoltaic power station, energy storage system, other high voltage input industrial equipment
- Input reversed polarity protection, UVP
- Output protection, OCP and SCP
- No minimum load requirement

Model Selection Table

Model	Dimensions (L*W*H)	Output power		Output voltage/current		Typical efficiency (Vin=800VDC)
		RATED	PULSE	RATED	PULSE	
GH350-V2S12U-SE	201*70*42mm	150W	260W (3min)	12V/12.5A	12V/21.7A	82%
GH350-V2S15U-SE				15V/10.0A	15V/17.3A	83%
GH350-V2S24U-SE		200W	350W (3min)	24V/8.33A	24V/14.6A	87%
GH350-V2S28U-SE				28V/7.14A	28V/12.5A	87%
GH350-V2S32U-SE				32V/6.25A	32V/10.9A	88%
GH350-V2S48U-SE				48V/4.16A	48V/7.29A	90%

Note1: Adding suffix of “-Lxx” means the module has input and output wires, and “xx” is the length with unit of cm, please reference to the related description in the dimension drawing.

Note2: For module with output voltage of 24V (or higher), 260W output power can be used if suitable fan is adapted, and less than 200W if no fan is available, please reference to the derating curves.

GH350-V4SxxU-S

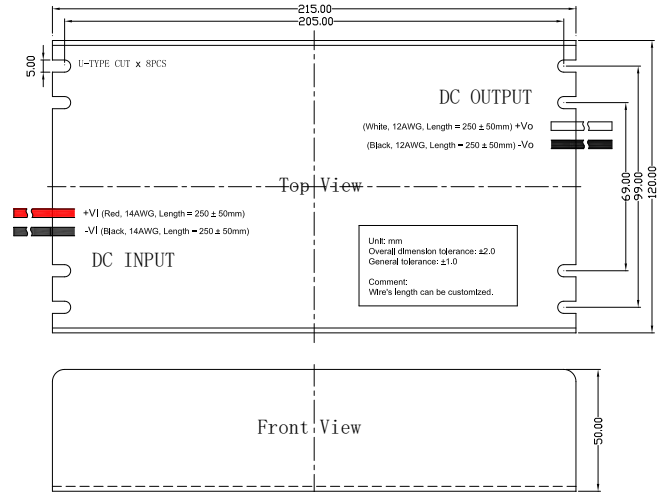

DC-DC Power Supply Module Ultra wide input, isolated single output

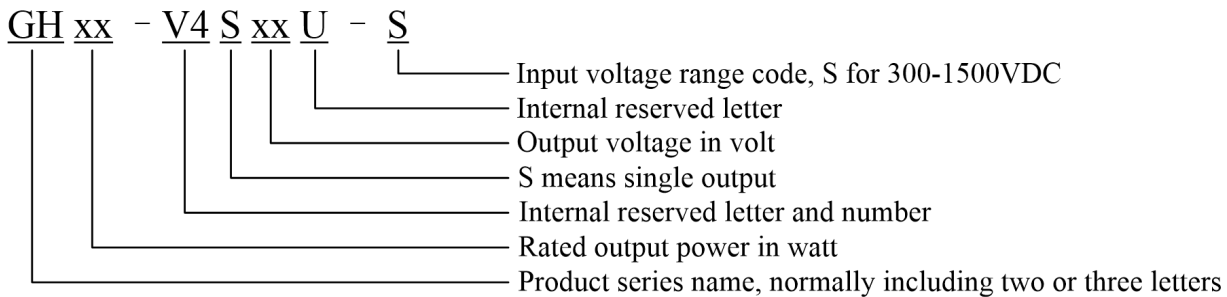

Product Characteristics

- Ultra wide input voltage range, 300-1500VDC
- High reliability, industrial grade
- Input and output isolation, 4000VDC
- Applications: photovoltaic power station, energy storage system, other high voltage input industrial equipment
- Input reversed polarity protection, UVP
- Output protection, OCP and SCP
- No minimum load requirement

Model Selection Table

Model	Dimensions (L*W*H)	Rated power	Rated output voltage/current		Typical efficiency (Vin=1000VDC)
			Vo	Io	
GH350-V4S24U-S	215*120*50.0mm	350W	24V	14580mA	85%
GH350-V4S28U-S			28V	12500mA	85%
GH350-V4S32U-S			32V	10930mA	86%
GH350-V4S48U-S			48V	7290mA	88%
GH350-V4S110U-S			110V	3180mA	88%

VA350-V6Sxx

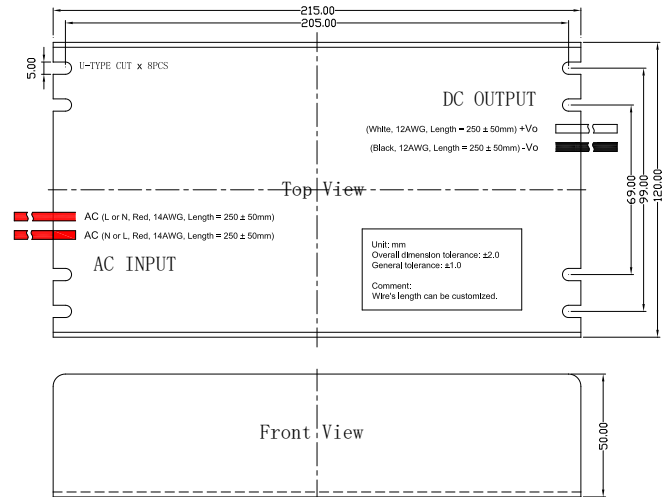

AC-DC Power Supply Module AC or DC input, isolated single output

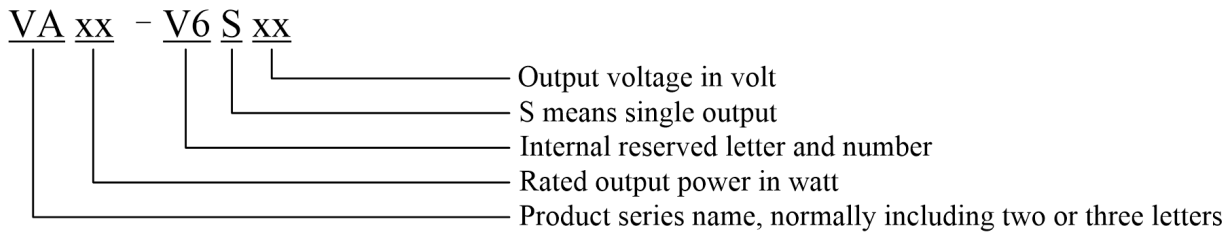

Product Characteristics

- Input voltage range, 600-1000VAC or 840-1400VDC
- Input under voltage protection
- High reliability, industrial grade
- Output protection, OCP and SCP
- Input and output isolation, 3000VAC
- No minimum load requirement
- Applications: photovoltaic power station, energy storage system, other high voltage input industrial equipment

Model Selection Table

Model	Dimensions (L*W*H)	Rated power	Rated output voltage/current		Typical efficiency (Vin=800VAC)
			Vo	Io	
VA350-V6S24	215*120*50.0mm	350W	24V	14580mA	83%
VA350-V6S28			28V	12500mA	83%
VA350-V6S32			32V	10930mA	85%
VA350-V6S48			48V	7290mA	86%

GSAXXXXHS(D)-4(8)

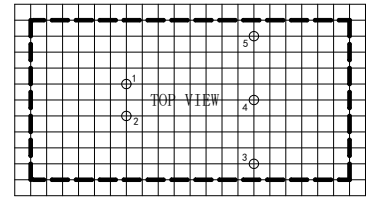
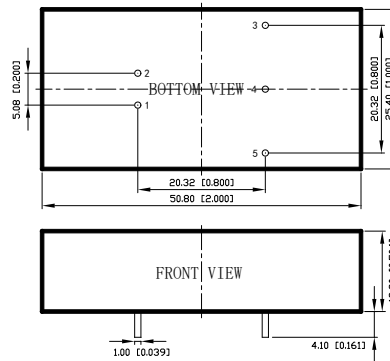

Note1: Grid 0.54mm±0.04mm
Note2: Advised through hole diameter, 1.5mm

Unit: mm[inch]
Pin diameter tolerance: ±0.10[±0.004]
General tolerance: ±0.50[±0.020]

Pin	1	2	3	4	5
Single output	-VI	+VI	+Vo	No Pin	-Vo
Dual output	-VI	+VI	+Vo	COM	-Vo

DC-DC Power Supply Module Low voltage input, high voltage output

GSA xx xxx HS(D) - 4(8)

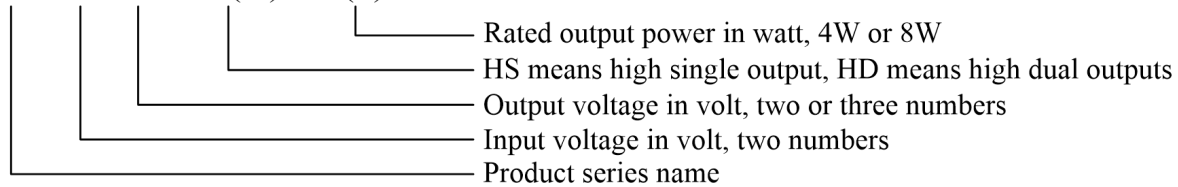

Product Characteristics

- Input voltage range, 10-18VDC or 18-36VDC
- High voltage output, from 50VDC to 600VDC
- DIP 2"x1" package with international pin assignment
- High reliability, industrial grade
- Input and output isolation, 1500VDC
- No minimum load requirement
- Applications: industrial equipment, electrolytic capacitor charger, instruments, meters, medical equipment.

Model Selection Table

Model	Input voltage (VDC)			Vo (VDC)	Io (mA)	Typical efficiency (Vin=TYP)
	MIN	TYP	MAX			
GSA1250HS-8	10	12	18	50	160	80%
GSA12100HS-8				100	80	78%
GSA12150HS-8				150	53	77%
GSA12170HS-8				170	47	76%
GSA12200HS-8				200	40	75%
GSA12300HS-8				300	26	73%
GSA12400HS-8				400	20	72%
GSA12500HS-4				500	8	68%
GSA12600HS-4				600	6	61%

GSA2450HS-8	18	24	36	50	160	80%
GSA24100HS-8				100	80	79%
GSA24150HS-8				150	53	78%
GSA24170HS-8				170	47	76%
GSA24200HS-8				200	40	77%
GSA24300HS-8				300	26	75%
GSA24400HS-8				400	20	73%
GSA24500HS-4				500	8	66%
GSA24600HS-4				600	6	63%
GSA1250HD-8	10	12	18	±50	±80	78%
GSA12100HD-8				±100	±40	75%
GSA12150HD-8				±150	±26	73%
GSA12200HD-8				±200	±20	72%
GSA12250HD-4				±250	±8	68%
GSA12300HD-4				±300	±6	61%
GSA2450HD-8	18	24	36	±50	±80	79%
GSA24100HD-8				±100	±40	77%
GSA24150HD-8				±150	±26	76%
GSA24200HD-8				±200	±20	75%
GSA24250HD-4				±250	±8	73%
GSA24300HD-4				±300	±6	66%

Comment: Input voltage shall not exceed the maximum value, otherwise permanent and unrecoverable damage be caused.

GHAxxxxxHS(D)-xx

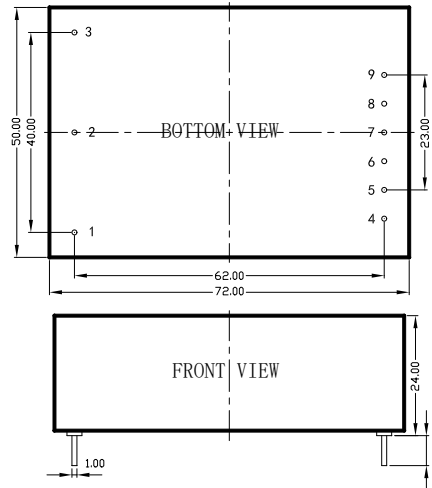

PIN	FUNCTION	
	HS-xx	HD-xx
1	NO PIN	NO PIN
2	-VI	-VI
3	+VI	+VI
4	NO PIN	NO PIN
5	-Vo	-Vo
6	NO PIN	NO PIN
7	NO PIN	COM
8	NO PIN	NO PIN
9	+Vo	+Vo

Unit: mm
 Pin diameter tolerance: ± 0.10
 General tolerance: ± 0.50

DC-DC Power Supply Module Low voltage input, high voltage output

GHA xx xxx HS(D) - xx

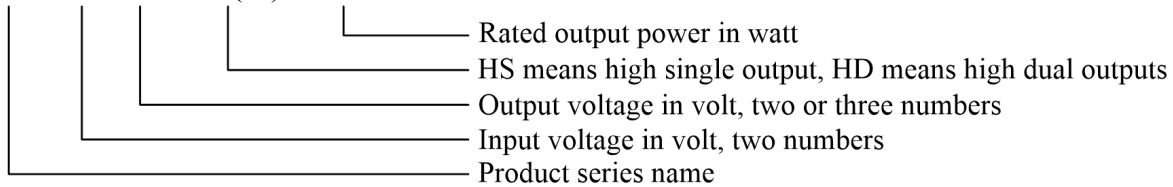

Product Characteristics

- International industry standard pin-out
- Metal case, good for heat dissipation
- Applicable to automation control equipment, instrumentation, communication equipment, smart home and other industrial and civil fields.
- Rated input voltage is 12VDC or 24VDC or 48VDC
- Input and output isolation, 1500VDC

Model Selection Table

Model	Input voltage (VDC)			Output voltage (VDC)	Output current (mA)	TYP EFF (%)
	MIN	TYP	MAX			
GHA12100HS-20	10	12	18	100	200	82
GHA12200HS-20				200	100	82
GHA12300HS-20				300	67	81
GHA12400HS-20				400	50	80
GHA12100HD-20				±100	100	82
GHA12150HD-20				±150	67	81
GHA12200HD-20				±200	50	80
GHA24100HS-25				18	24	36
GHA24200HS-25	200	125	84			
GHA24300HS-25	300	83	83			

GHA24400HS-25				400	63	82
GHA24100HD-25				±100	125	84
GHA24150HD-25				±150	83	83
GHA24200HD-25				±200	63	82
GHA24500HS-20				500	40	82
GHA24600HS-20				600	33	81
GHA24800HS-20	18	24	36	800	25	80
GHA241000HS-15				1000	15	79
GHA241200HS-15				1200	13	78
GHA241500HS-15				1500	10	76
GHA48100HS-30				100	300	86
GHA48200HS-30				200	150	86
GHA48300HS-30				300	100	85
GHA48400HS-30				400	75	84
GHA48100HD-30				±100	150	86
GHA48150HD-30				±150	100	85
GHA48200HD-30	36	48	72	±200	75	84
GHA48500HS-25				500	50	83
GHA48600HS-25				600	42	82
GHA48800HS-25				800	31	81
GHA481000HS-20				1000	20	80
GHA481200HS-20				1200	17	79
GHA481500HS-20				1500	13	77

Note: Input voltage should not exceed the maximum value, otherwise power supply module may be damaged.

GVAxxxxxxAS-xx

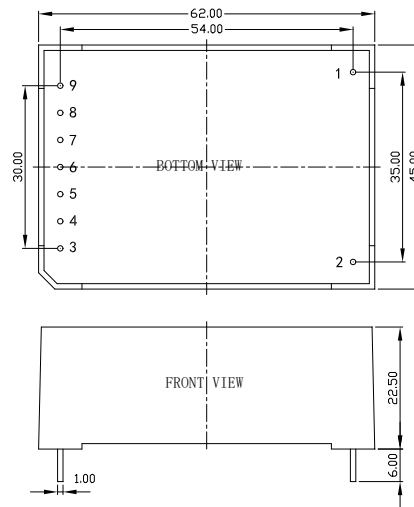

Pin	Function
1	-Vo
2	+Vo
3	+VI
4	-VI
5	GND
6	ADJ
7	Vref
8	Idis
9	Vdis

Unit: mm
Pin diameter tolerance: ± 0.10
Pin length tolerance: ± 2.00
General tolerance: ± 0.50

DC-DC Power Supply Module Low voltage input, non-isolated high voltage output

GVA xx xxxx AS - xx

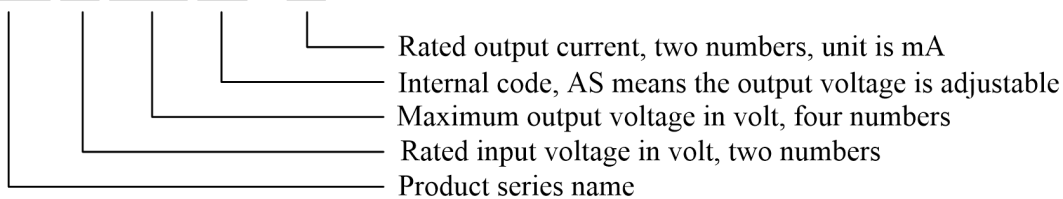

Product Characteristics

- Plastic case, full-seal glue, PCB assembled
- Non-isolated, high output voltage, high power
- With voltage and current detection signals
- The output voltage is linearly adjustable (by ADJ PIN)
- It is suitable for automation control equipment, instrumentation, electric power equipment, industrial control equipment, new energy vehicle charging and other fields, where DC high voltage is needed.

Model Selection Table

Model	Input voltage (VDC)			Vo (VDC)		Io (mA)		TYP EFF (%)
	MIN	TYP	MAX	MIN	MAX	MIN	MAX	
GVA241000AS-30	21.6	24.0	26.4	0	1000	0	30	85
GVA121200AS-10	11.4	12.0	12.6	0	1200	0	10	62

TYP EFF Test condition is shown below:

GVA241000AS-30: $V_{in} = 24VDC$, $V_o = 500VDC/30mA$.

GVA121200AS-10: $V_{in} = 12VDC$, $V_o = 600VDC/10mA$.

Interface Signals

Item	Test Condition / Description	MIN	TYP	MAX
ADJ voltage (Control voltage)	100% of ADJ = 5VDC	0	-	5VDC
	Input PIN, output voltage is set by ADJ			
Vdis voltage	Output PIN, detection of output voltage. Range from 0VDC to 5VDC, corresponding to the output voltage range linearly.			
Idis voltage	Output PIN, detection of output current. Range from 0VDC to 5VDC, corresponding to the output current range linearly.			

Derating curve and other characteristic curves

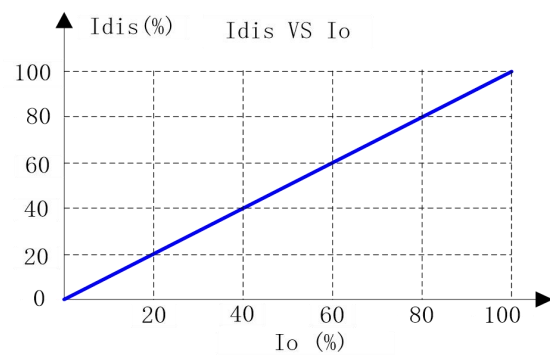
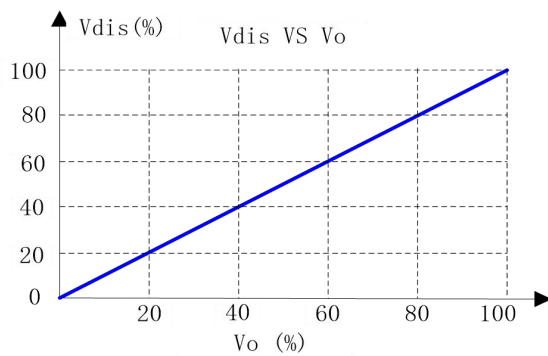
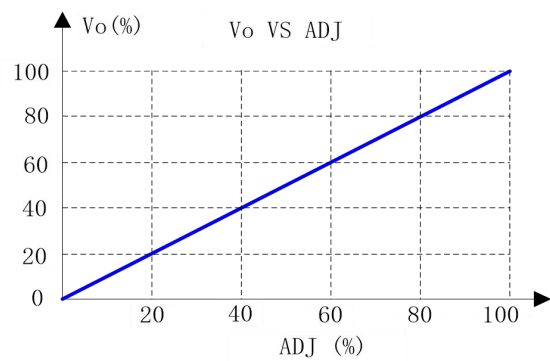
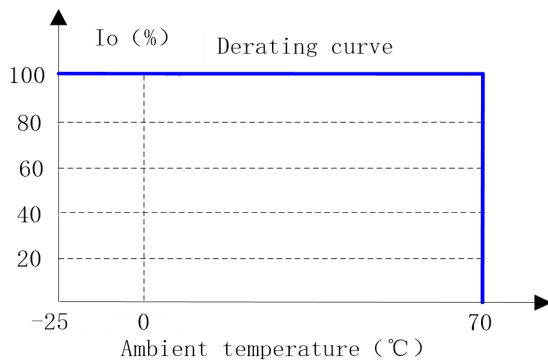

Application Notes

1. Typical application

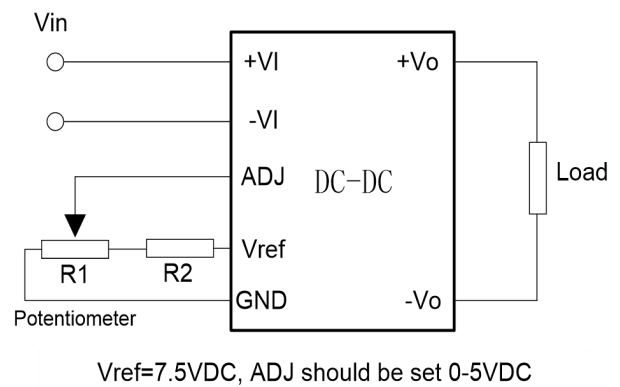
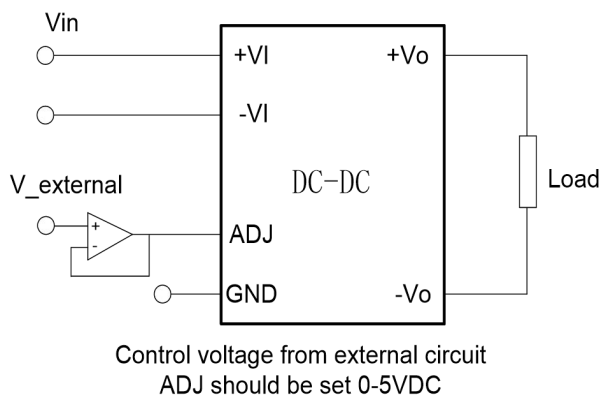

PRODUCT MAP



CONTACT METHODS 联系方式

Company name	Guangzhou Guantu Electronic Technology Co., Ltd (GTL-POWER) 广州冠图电子科技有限公司		
Company address	No. 505, West Building, Jinghua Information Building, No. 138, Gaopu Road, Tianhe District, Guangzhou, China 中国·广州市天河区高普路 138 号京华信息大楼西座 505		
Company website	http://www.gtl-power.com		
Company telephone	+086 020-3889 5530 / 020-3698 9089		
Sales manager	He Wei	+086 13826177426	hewei@gtl-power.com
Product manager	Deng Yanping	+086 15017573792	dengyanping@gtl-power.com

AUTHORIZED AGENT CONTACT METHODS (Outside Chinese mainland)

授权代理商联系方式（中国大陆以外地区）

Company name	ShenZhen ShenMing tesco business Co., Ltd (SMYG LIMITED) 深圳深铭易购商务有限公司		
Company address	6th Floor, 3 Phase, HALO Plaza, No.1007 Bao'an North Road, Luohu District, Shenzhen, China 中国·深圳市罗湖区宝安北路 1007 号 HALO 广场三期 6 楼		
Company website	http://www.smbom.com		
Company telephone	+086 0755-82722999		
Sales manager	Cai Minghuai	+086 13433333999	smyg@szsmyg.com
Sales	Lisa	+086 17704034310	lisa@szsmyg.com